

# TORINO TORINO - E

Trincia laterale/Side mower/Broyeur d'accotement/Seitlicher Mulcher

**OMARV**

 Trincia laterale

 Side mower







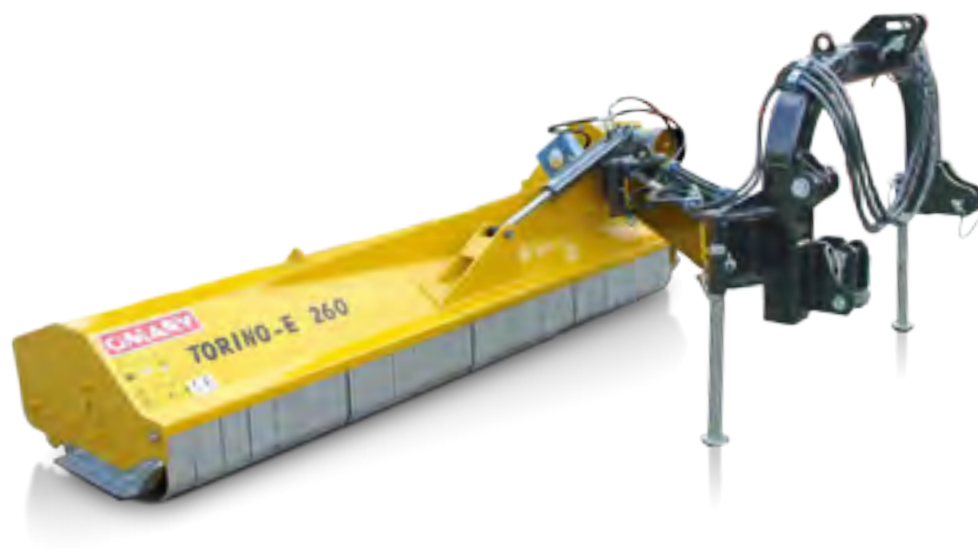

 Broyeur d'accotement

 Seitlicher Mulcher

MOD: 140 | 160 | 180 | 200 | 220 | 240 | 260



## SPECIFICHE TECNICHE - TECHNICAL SPECIFICATIONS - SPÉCIFICATIONS TECHNIQUES - TECHNISCHE DATEN

MOD:	140	160	180	200	220	240	260
 (Work)cm	140	160	180	200	220	240	260
 TOT cm	165	185	215	227	245	-	-
 TOT cm mod. E	-	210	230	250	270	290	310
 Kg	680	680	710	740	770	-	-
 Kg mod. E	-	800	840	870	890	980	1000
 HP	50   65	60   70	65   80	70   80	80   90	100   120	100   120
 No. *	32   64	36   72	40   80	44   88	48   96	52   104	56   112
 RPM	540	540	540	540	540	540	540

\* da specificare al momento dell'ordine/specify in the order/a preciser a la comande/bitte bei der bestellung angeben

**DESCRIZIONE**

- Ammortizzatore oleopneumatico
- Giri rotore: 1780 g/min
- Gruppo moltiplicatore con ruota libera interna
- Attacco terzo punto cat. 2
- Ingrassaggio centralizzato
- Tendicinghia automatico SPBX
- Doppia centina
- N. 2 Controcoltelli
- Slitte laterali
- Diametro rullo posteriore regolabile: 180 mm

**DESCRIPTION**

- Oleo-pneumatic shock absorber
- N° of RPM: 1780
- Gearbox with internal free wheel
- Three point linkage cat. 2
- Centralised greaser
- Automatic belt tightener SPBX
- Double rib
- No.2 counter-knives
- Skids
- Ø of adjustable rear roller: 180 mm

**DESCRIPTION**

- Amortisseur oleo-pneumatique
- Vitesse rotor: 1780 t/min
- Boitier avec roue libre
- Type attelage cat. 2
- Graissage centralisé
- Tendeur automatique de courroie : SPBX
- Double blindage
- No. 2 contre-couteaux
- Patins réglable
- Ø du rouleaux arrière réglable: 180 mm

**BESCHREIBUNG**

- Hydropneumatischer stoßdämpfer
- Nr. U/min: 2050
- Getriebe mit integrierten freilauf
- Dreipunktboch: Kat. 2
- Zentralschmierung
- Automatischer keilriemenspanner SPBX
- Doppeltes Gehäuse
- No.2 gegenscheide
- Kufen
- Verstellbare und sibsreinigende walze: Ø 180 mm

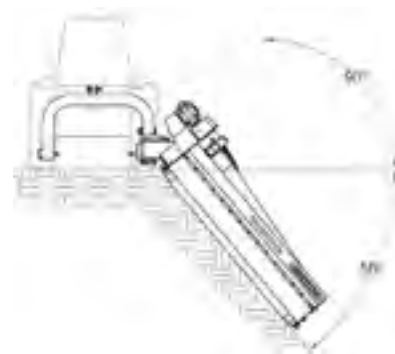
**1 TORINO****2 TORINO-E****OPZIONI & ACCESSORI - OPTIONS & ACCESSORIES - OPTIONS & ACCESSOIRES - OPTIONEN & ZUBEHÖR**

CARDANO STANDARD/Standard PTO shaft/  
Cardan normal/Standard gelenkwelle

CARDANO DOPPIO OMOCINETICO/Homocinetic PTO shaft on both sides/  
Cardan homocinétique double/Beiderseitige weitwinkelgelenkwelle

**OMARV**  
MACCHINE AGRICOLE

50  
anni di esperienza - dal 1943

The italian  
technology  
in the world

OMARV S.R.L. - Via G. Abbate  
14054 - Castagnole delle Lanze (AT)  
www.omarv.com - info@omarv.com

Rivenditore autorizzato/Authorized dealer/  
Concessionnaire autorisé/Autorisierten Händler

